

TML Series

TML 1320



13 l/m
3.4 USGPM



max 200 BAR
2900 P.S.I.

APPLICAZIONI - APPLICATIONS



MANUTENZIONE
MAINTENANCE



PROCESSI INDUSTRIALI
INDUSTRIAL PROCESSES



AUTOLAVAGGIO
CARWASH



EDILIZIA
CONSTRUCTION



SANIFICAZIONE
SANITIZATION

TECHNICAL PLUS:



USCITA ALBERO DX
RIGHT DRIVE SHAFT



CARTER REVERSIBILE, PER USCITA ALBERO SX O DX
REVERSIBLE CRANKCASE FOR LEFT OR RIGHT



BIELLE IN LEGA TONOLLI 328
CONRODS IN HYPER 328 TONOLLI ALLOY



GUARNIZIONI TENUTA ACQUA NBR (BUNA)
NBR (BUNA) WATER SEALS



GUARNIZIONI ANT. "V"
GUARNIZIONI POST. "V"
"V" FRONT SEALS - "V" BACK SEALS

OPTIONAL:



USCITA ALBERO LATO SX
LEFT DRIVE SHAFT



RIDUTTORE PER MOTORE TERMICO
GEARBOX FOR GAS/DIESEL ENGINE



FLANGIA E GRUNTO ELASTICO PER MOTORE
ELETTRICO B3-B14
BELL HOUSING AND FLEXIBLE COUPLING
FOR ELECTRIC MOTOR B3-B14



KIT PIEDINI IN LAMIERA
D'ACCIAIO ZINCATI
GALVANIZED STEEL
MOUNTING RAILS KIT



BIELLE IN BRONZO
BRONZE CONRODS

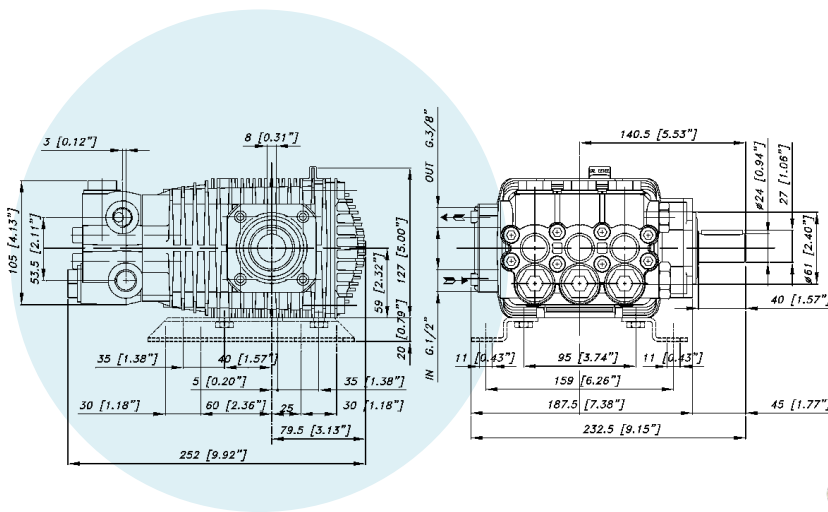

CARATTERISTICHE TECNICHE SPECIFICATIONS

Peso - Weight	9,5 Kg	21 lb
IN	1/2 BSP	
Pressione Min - Min Pressure	-0,1 BAR	-1.5 P.S.I.
Pressione Max - Max Pressure	6 BAR	87 P.S.I.
OUT	3/8 BSP	
Albero - Shaft	Ø 24 mm	
Max. Temperatura - Max. Temperature	60 °C	140 °F
Tipo olio - Oil type	SAE 75 - W 90	
Capacità olio - Oil capacity	0,7 lt	0.18 U.S.G.



CODICE CODE	MODELLO MODEL	Press. Max Max Pres.		RPM 950				RPM 1450				RPM 1725				Pist. Plung.	Corsa Stroke
				Portata-Flow		Potenza-Power		Portata-Flow		Potenza-Power		Portata-Flow		Potenza-Power			
		BAR	P.S.I.	L/min	GPM	KW	HP	L/min	GPM	KW	HP	L/min	GPM	KW	HP	Dia. mm	mm
07.1000.97.A	TML 1220	200	2900	8	2,1	3,0	4,0	12	3,2	4,7	6,3	14	3,7	5,3	7,1	18	11,2
07.1001.97.A	TML 1320	200	2900	9	2,4	3,3	4,4	13	3,4	5,1	6,8	15	4,0	5,9	7,9	18	12,4
07.1002.97.A	TML 1520	200	2900	10	2,6	3,8	5,2	15	4,0	5,9	7,9	18	4,8	6,8	9,2	18	14,4
07.1004.97.A	TML 1720	200	2900	11	2,9	4,3	5,7	17	4,5	6,7	9,0	20	5,3	7,6	10,2	18	16
07.1006.97.A	TML 2020	200	2900	13	3,4	5,0	6,7	20	5,3	7,8	10,5	23	6,1	8,9	11,9	18	18,7